

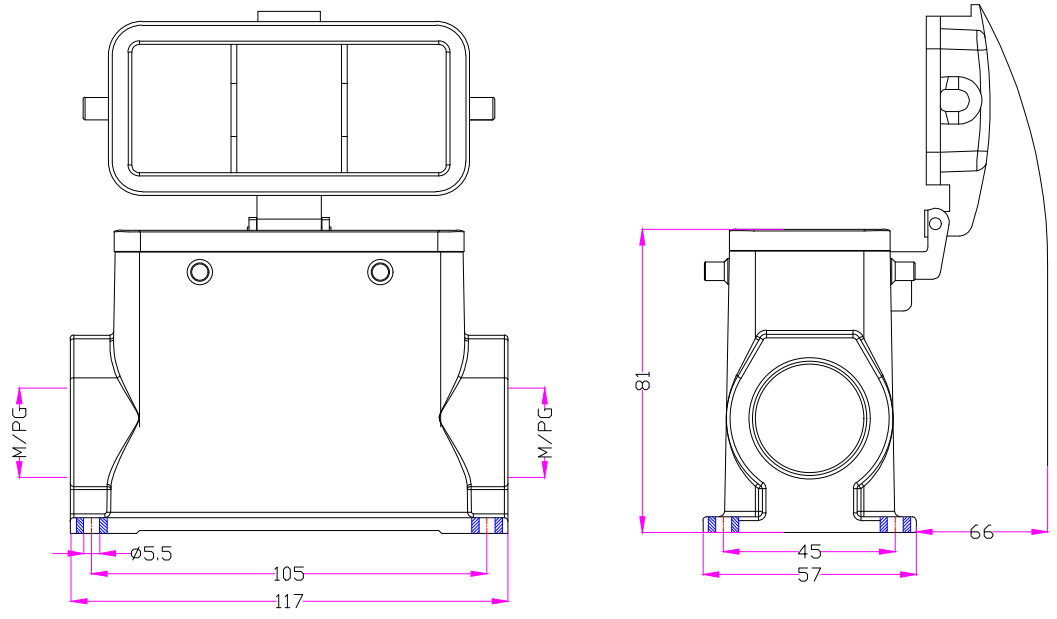

REVISION DATA				
SYM	ECN	DESCRIPTION	DATE	APPROVED



技术参数:
 材料: 压铸铝
 表面处理: 粉末喷涂
 颜色: RAL7037灰色
 温度范围: -40℃~+125℃
 防护等级: IP65 (联锁状态)
 密封元件: NBR
 出线方向: 侧出线
 螺纹规格: M32/2M32/PG21/2PG21/PG29/2PG29

Specifications:
 Material: aluminium die-cast
 Surface: powder-coated
 Color: Grey (RAL 7037)
 Limiting temperatures: -40℃~+125℃
 Degree of protection: IP65
 Hoods/Housings sealing: NBR
 Cable entry: Side entry
 Thread size: M32/2M32/PG21/2PG21/PG29/2PG29



Tolerance		SIGNATURE	DATE	Units	mm	 宁波欧科瑞连接器有限公司 NINGBO OKERUI CONNECTOR CO., LTD.	
0~≤20 ±0.15	DRAW			Size	A4		
20~≤50 ±0.25	DESIGN			Scale		PART NAME: HZW-H16B-SGH-4g-CV-M/PG	
50~≤80 ±0.35	CHECK			Sheet		Drawing NO.	REV
80~≤120 ±0.50	APPROVE			Proj.		Material	A